

MCBN IC045	MCKN IC045	MCLN IC046	MCNN IC046	MDJN IC047	MTQN IC047
MSDN IC048	MSSN IC048	MTJN IC049	MTEN IC049	DTFN IC050	MTFN IC050
MVJN IC051	MVQN IC051	MVVN IC052	WWLN IC052	MWLN IC053	MWLN-N IC053
SCBC IC054	SCKC IC054	SCLC IC055	SCL2C IC055	SCNC IC056	SDJC IC056
SDJ2C IC057	SDNC IC057	SDQC IC058	SDFC IC058	SSAC IC059	SSBC IC059
SSDC IC060	SSEC IC060	SSXC IC061	STAC IC062	STFC IC062	STGC IC063
CTYC IC063	SVJB IC064	SVJ2B IC064	SVQB IC065	SVVB IC065	

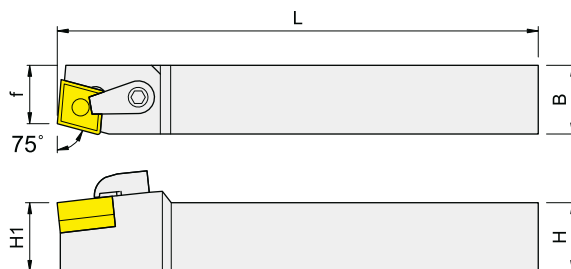

Right-hand shown

Order No. 訂購編碼	Dimensions, mm					Insert	Pin	Shim	Wrench	Screw	Clamp	Wrench
	H	B	L	H1	f							
IMCBN <sup>®</sup> <sub>L</sub> -2020K-12	20	20	125	20	17	CN..1204..	IMLP46-A	ICMS432	IPL25	IMS625TX	IMC620	IETL15
IMCBN <sup>®</sup> <sub>L</sub> -2525M-12	25	25	150	25	22					IMS630TX		
IMCBN <sup>®</sup> <sub>L</sub> -3232P-12	32	32	170	32	29							

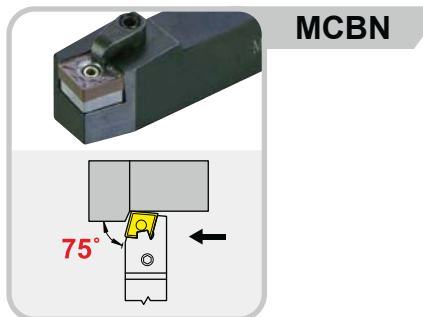
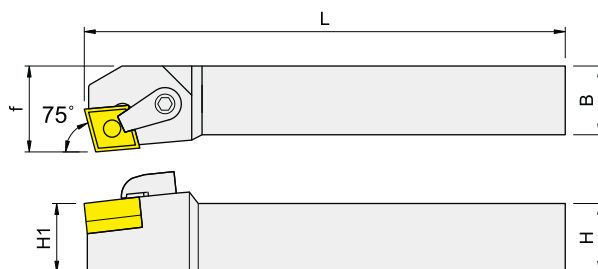
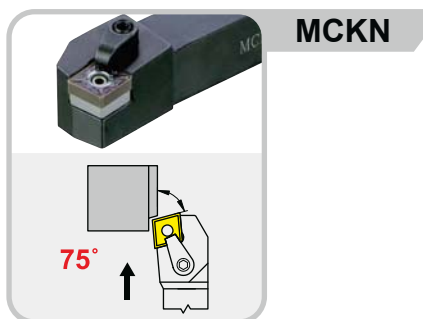

Right-hand shown

Order No. 訂購編碼	Dimensions, mm					Insert	Pin	Shim	Wrench	Screw	Clamp	Wrench
	H	B	L	H1	f							
IMCKN <sup>®</sup> <sub>L</sub> -1616K-12	16	16	125	16	20	CN..1204..	IMLP46-A	ICMS432	IPL25	IMS625TX	IMC620	IETL15
IMCKN <sup>®</sup> <sub>L</sub> -2020K-12	20	20	125	20	25					IMS630TX		
IMCKN <sup>®</sup> <sub>L</sub> -2525M-12	25	25	150	25	32							
IMCKN <sup>®</sup> <sub>L</sub> -3232P-12	32	32	170	32	40							

Turning Tools

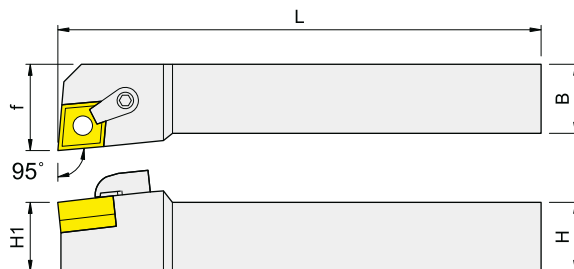
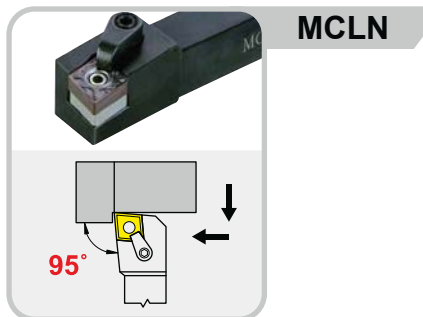

Right-hand shown

Order No. 訂購編碼	Dimensions, mm					Insert	Pin	Shim	Wrench	Screw	Clamp	Wrench
	H	B	L	H1	f							
IMCLN <sup>R</sup> <sub>L</sub> -1616K-12	16	16	125	16	20	CN..1204..	IMLP46-A	ICMS432	IPL25	IMS625TX	IMC620	IETL15
IMCLN <sup>R</sup> <sub>L</sub> -2020K-12	20	20	125	20	25							
IMCLN <sup>R</sup> <sub>L</sub> -2525M-12	25	25	150	25	32							
IMCLN <sup>R</sup> <sub>L</sub> -3232P-12	32	32	170	32	40							

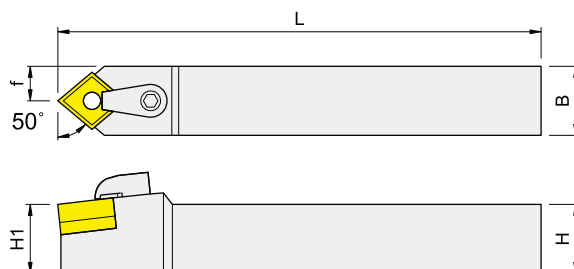
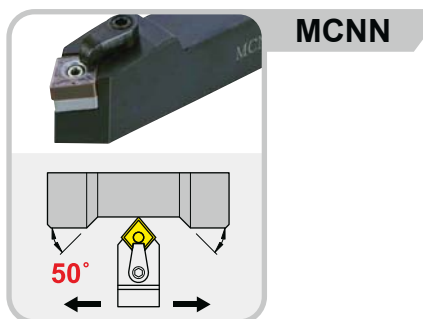

Order No. 訂購編碼	Dimensions, mm					Insert	Pin	Shim	Wrench	Screw	Clamp	Wrench
	H	B	L	H1	f							
IMCNNN-1616K-12	16	16	125	16	8	CN..1204..	IMLP46-A	ICMS432	IPL25	IMS625TX	IMC620	IETL15
IMCNNN-2020K-12	20	20	125	20	10							
IMCNNN-2525M-12	25	25	150	25	12.5							
IMCNNN-3232P-12	32	32	170	32	16							

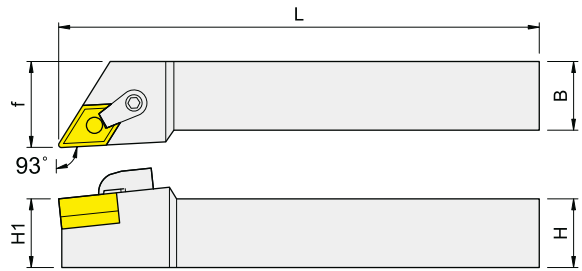
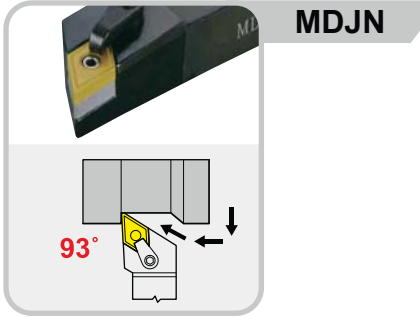

Order No. 訂購編碼	Dimensions, mm					Insert	Pin	Shim	Wrench	Screw	Clamp	Wrench
	H	B	L	H1	f							
IMDJN <sup>R</sup> / <sub>L</sub> -2020K-1504	20	20	125	20	25	DN..1504..	IMLP46-AL	IDMS442	IPL25	IMS625TX	IMC622	IETL15
IMDJN <sup>R</sup> / <sub>L</sub> -2525M-1504	25	25	150	25	32					IMS630TX		
IMDJN <sup>R</sup> / <sub>L</sub> -2020K-1506	20	20	125	20	25	DN..1506..	IMLP46-AL	IDMS432	IPL25	IMS625TX	IMC622	IETL15
IMDJN <sup>R</sup> / <sub>L</sub> -2525M-1506	25	25	150	25	32					IMS630TX		

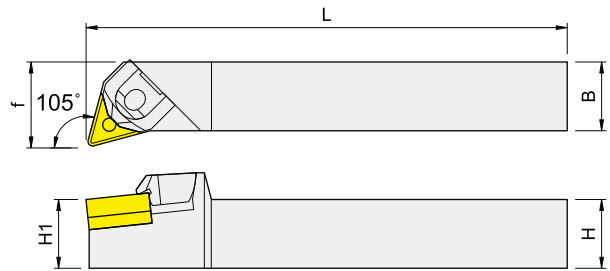
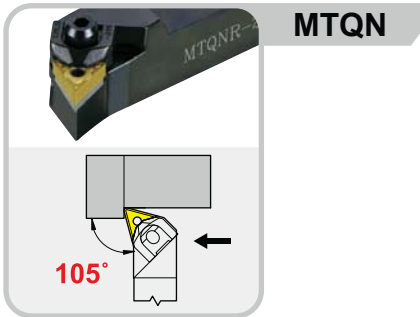

Order No. 訂購編碼	Dimensions, mm					Insert	Pin	Screw	Wrench	Shim	Clamp	Wrench
	H	B	L	H1	f							
IMTDN <sup>R</sup> / <sub>L</sub> -2020K-16	20	20	125	20	25	TN..1604..	IMCP3	IMCS3S-11	IPL30	ITWS322	IMCW3-P40	IPL40
IMTDN <sup>R</sup> / <sub>L</sub> -2525M-16	25	25	150	25	32							

Turning Tools

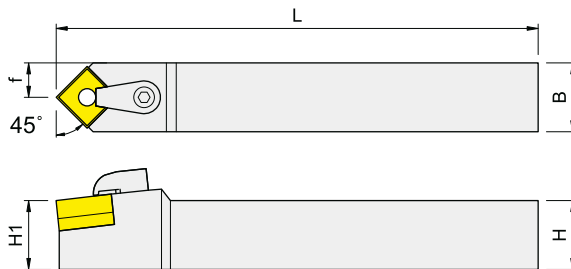
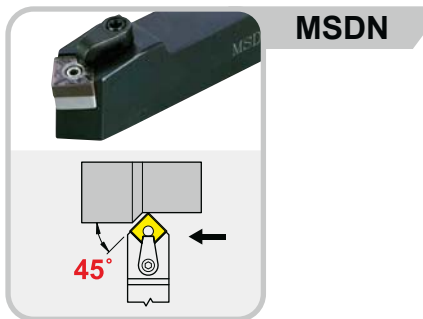

Right-hand shown

Order No. 訂購編碼	Dimensions, mm					Insert	Pin	Shim	Wrench	Screw	Clamp	Wrench
	H	B	L	H1	f							
IMSDNN-2020K-12	20	20	125	20	10	SN..1204..	IMLP46-A	ISMS432	IPL25	IMS625TX	IMC620	IETL15
IMSDNN-2525M-12	25	25	150	25	12.5					IMS630TX		

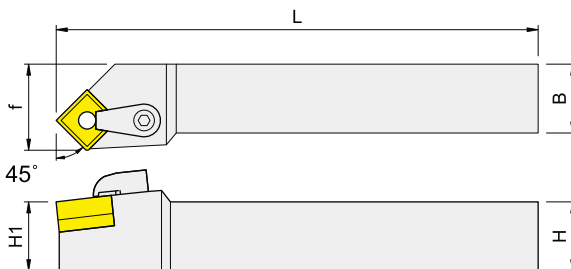
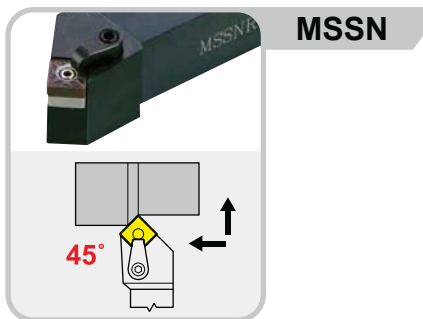

Right-hand shown

Order No. 訂購編碼	Dimensions, mm					Insert	Pin	Shim	Wrench	Screw	Clamp	Wrench
	H	B	L	H1	f							
IMSSN <sup>R</sup> <sub>L</sub> -1616K-12	16	16	125	16	20	SN..1204..	IMLP46-A	ISMS432	IPL25	IMS625TX	IMC620	IETL15
IMSSN <sup>R</sup> <sub>L</sub> -2020K-12	20	20	125	20	25					IMS630TX		
IMSSN <sup>R</sup> <sub>L</sub> -2525M-12	25	25	150	25	32					IMS630TX		

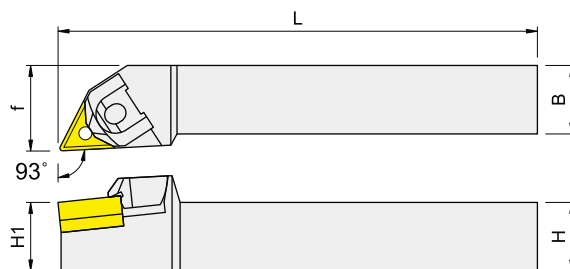
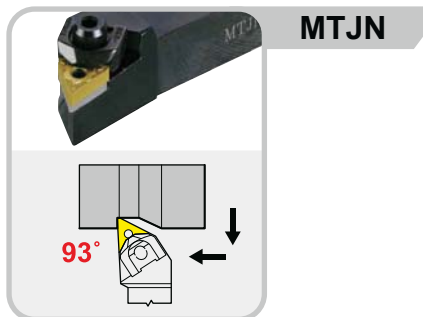

Right-hand shown

Order No. 訂購編碼	Dimensions, mm					Insert	Pin	Screw	Wrench	Shim	Clamp	Wrench
	H	B	L	H1	f							
IMTJN <sup>R</sup> <sub>L</sub> -1216K-16	12	16	125	16	21	TN..1604..	IMCP3	IMCS3S-11	IPL30	ITWS322	IMCW3-P40	IPL40
IMTJN <sup>R</sup> <sub>L</sub> -1616K-16	16	16	125	16	21							
IMTJN <sup>R</sup> <sub>L</sub> -2020K-16	20	20	125	20	25							
IMTJN <sup>R</sup> <sub>L</sub> -2525M-16	25	25	150	25	32							
IMTJN <sup>R</sup> <sub>L</sub> -3232P-16	32	32	170	32	40							

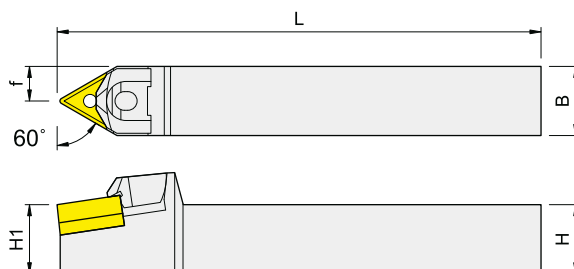
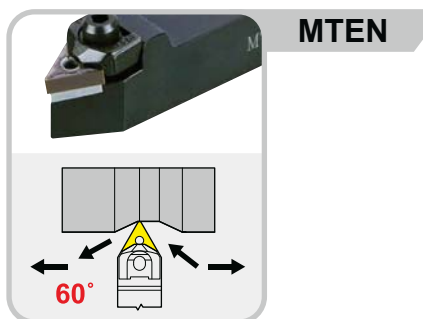

Order No. 訂購編碼	Dimensions, mm						Insert	Pin	Screw	Wrench	Shim	Clamp	Wrench
	H	B	L	H1	f								
IMTENN-1216K-16	12	16	125	16	8	TN..1604..	IMCP3	IMCS3S-09	IPL30	ITWS322	IMCW3-P40	IPL40	
IMTENN-1616K-16	16	16	125	16	8								
IMTENN-2020K-16	20	20	125	20	10								
IMTENN-2525M-16	25	25	150	25	12.5								

Turning Tools

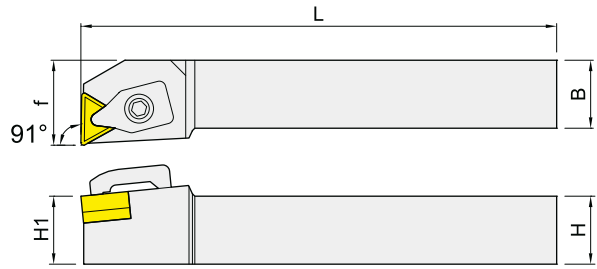
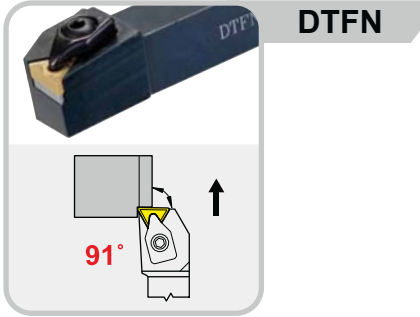

Right-hand shown

Order No. 訂購編碼	Dimensions, mm					Insert	Shim	Screw	Wrench	Clamp	Wrench
	H	B	L	H1	f						
IDTFN <sup>R</sup> <sub>L</sub> -1616K-16	16	16	125	16	20	TN..1604..	ITWS322	IMS4008H	IPL25	IMCD324B	IPL40
IDTFN <sup>R</sup> <sub>L</sub> -2020K-16	20	20	125	20	25						
IDTFN <sup>R</sup> <sub>L</sub> -2525M-16	25	25	150	25	32						

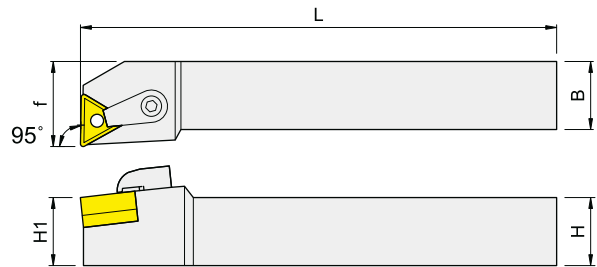
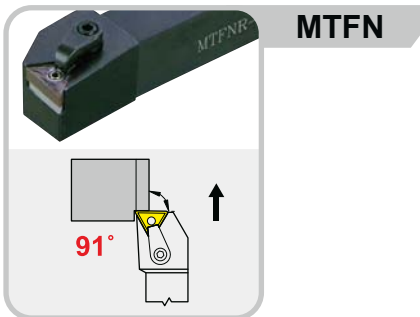

Right-hand shown

Order No. 訂購編碼	Dimensions, mm					Insert	Pin	Shim	Wrench	Screw	Clamp	Wrench
	H	B	L	H1	f							
IMTFNR-1616K-16	16	16	125	16	20	TN..1604..	IMLP34L-A	ITMS322	IPL20	IMS625TX	IMC620	IETL15
IMTFNR-2020K-16	20	20	125	20	25							
IMTFNR-2525M-16	25	25	150	25	32							

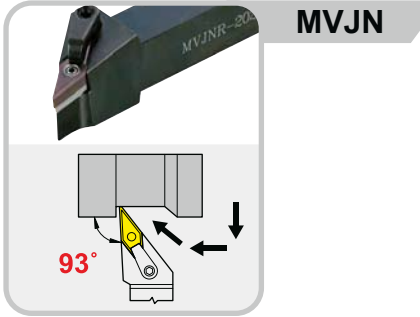

**MVJN**

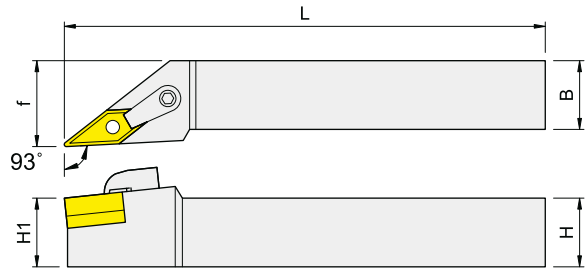

Right-hand shown

Order No. 訂購編碼	Dimensions, mm					Insert	Pin	Shim	Wrench	Screw	Clamp	Wrench
	H	B	L	H1	f							
IMVJN <sup>R</sup> <sub>L</sub> -1616K-16	16	16	125	16	21	VN..1604..	IMLP34L-A	IVMS322	IPL20	IMS625TX	IMC622	IETL15
IMVJN <sup>R</sup> <sub>L</sub> -2020K-16	20	20	125	20	25					IMS630TX		
IMVJN <sup>R</sup> <sub>L</sub> -2525M-16	25	25	150	25	32							

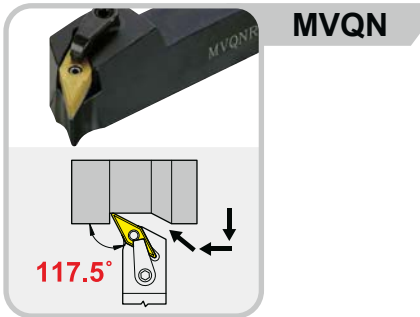

**MVQN**

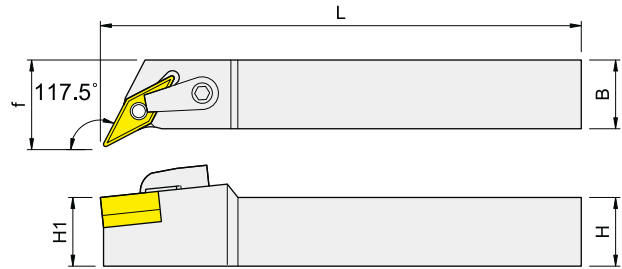

Right-hand shown

Order No. 訂購編碼	Dimensions, mm					Insert	Pin	Shim	Wrench	Screw	Clamp	Wrench
	H	B	L	H1	f							
IMVQN <sup>R</sup> <sub>L</sub> -2020K-16	20	20	125	20	25	VN..1604..	IMLP34L-A	IVMS322	IPL20	IMS625TX	IMC622	IETL15
IMVQN <sup>R</sup> <sub>L</sub> -2525M-16	25	25	150	25	32					IMS630TX		

Turning Tools



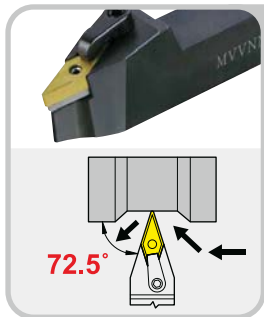

**MVVN**

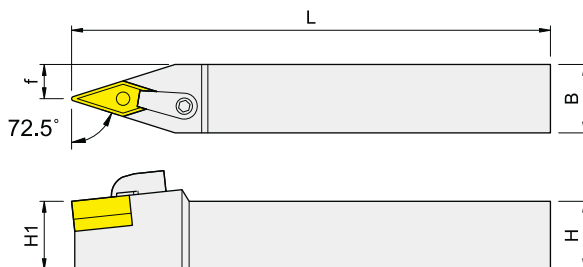

Order No. 訂購編碼	Dimensions, mm					Insert	Pin	Shim	Wrench	Screw	Clamp	Wrench
	H	B	L	H1	f							
IMVVNN-1616K-16	16	16	125	16	8	VN..1604..	IMLP34L-A	IVMS322	IPL20	IMS625TX	IMC622	IETL15
IMVVNN-2020K-16	20	20	125	20	10					IMS630TX		
IMVVNN-2525M-16	25	25	150	25	12.5							

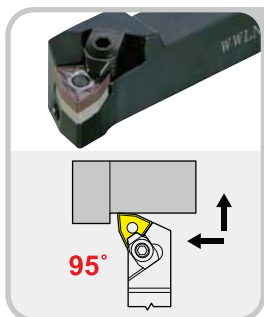

**WWLN**

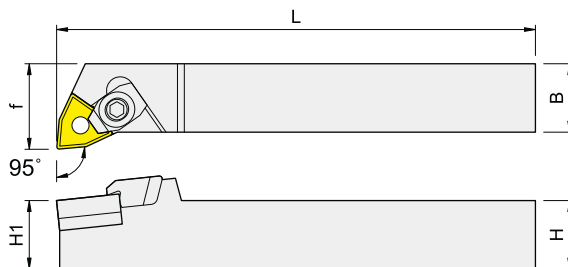

Right-hand shown

Order No. 訂購編碼	Dimensions, mm					Insert	Pin	Screw	Wrench	Shim	Clamp	Wrench
	H	B	L	H1	f							
IWWLN <sup>R</sup> / <sub>L</sub> -2020K-08	20	20	125	20	25	WN..0804..	IMCP4	IMCS3S-09	IPL30	IWMS432	IWCW6-P4	IPL40
IWWLN <sup>R</sup> / <sub>L</sub> -2525M-08	25	25	150	25	32							

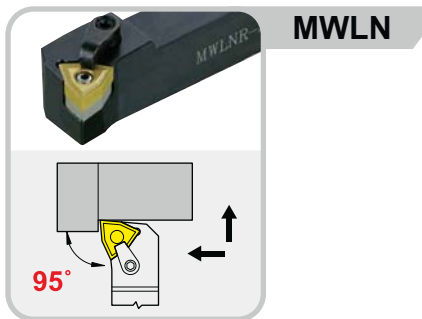

**MWLN**

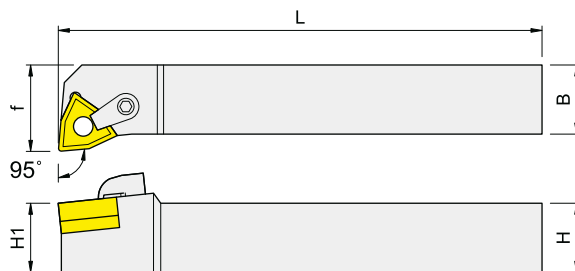

Right-hand shown

Order No. 訂購編碼	Dimensions, mm					Insert	Pin	Shim	Wrench	Screw	Clamp	Wrench
	H	B	L	H1	f							
IMWLN <sup>R</sup> /L-2020K-08	20	20	125	20	25	WN..0804..	IMLP46-A	IWMS432	IPL25	IMS625TX	IMC620	IETL15
IMWLN <sup>R</sup> /L-2525M-08	25	25	150	25	32					IMS630TX		

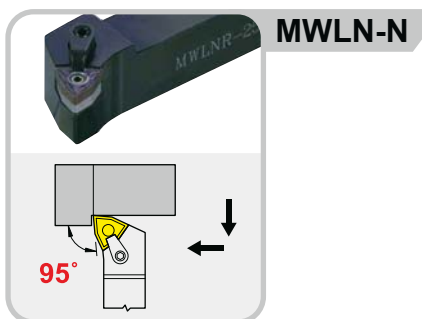

**MWLN-N**

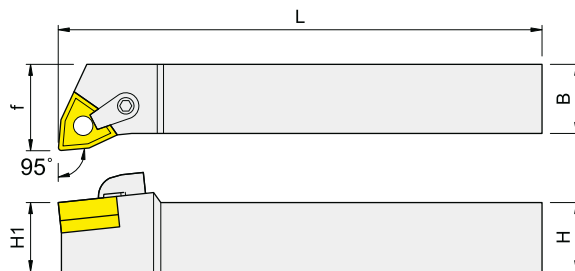

Right-hand shown

Order No. 訂購編碼	Dimensions, mm					Insert	Pin	Shim	Wrench	Screw	Clamp	Wrench
	H	B	L	H1	f							
IMWLN <sup>R</sup> /L-2020K-08N	20	20	125	20	25	WN..0804..	IMLP46-A	IWMS432	IPL25	IMS625TX	IMC620	IETL15
IMWLN <sup>R</sup> /L-2525M-08N	25	25	150	25	32					IMS630TX		

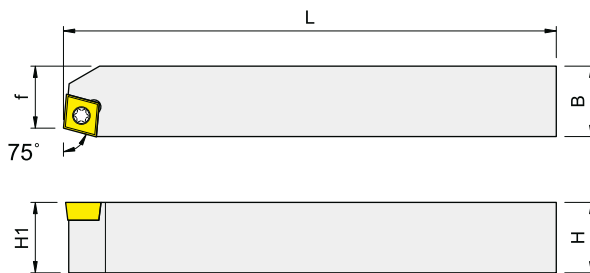
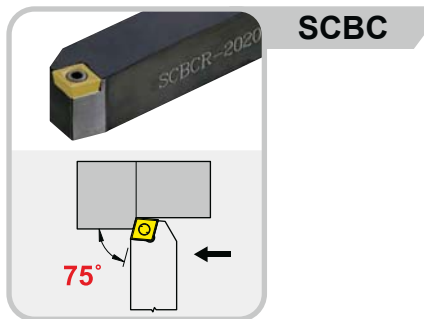

Right-hand shown

Order No. 訂購編碼	Dimensions, mm					Insert	Clamp 	Wrench 
	H	B	L	H1	f			
ISCB <sup>R</sup> <sub>L</sub> -2020K-09	20	20	125	20	17.5	CC..09T3..	IMS4011A	ITK15

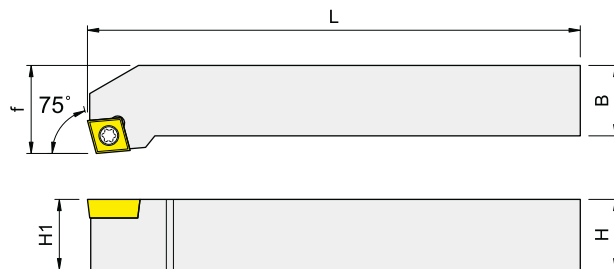
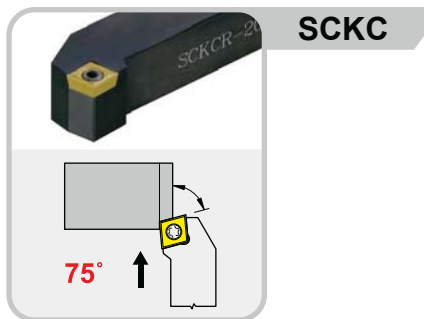

Right-hand shown

Order No. 訂購編碼	Dimensions, mm					Insert	Clamp 	Wrench 
	H	B	L	H1	f			
ISCK <sup>R</sup> <sub>L</sub> -1212K-09	12	12	125	12	16	CC..09T3..	IMS4011A	ITK15
ISCK <sup>R</sup> <sub>L</sub> -1616K-09	16	16	125	16	20			
ISCK <sup>R</sup> <sub>L</sub> -2020K-09	20	20	125	20	25			
ISCK <sup>R</sup> <sub>L</sub> -2525M-09	25	25	150	25	32			

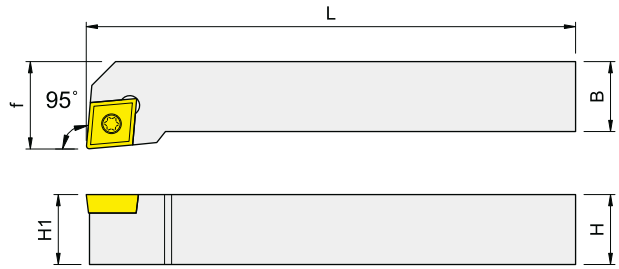
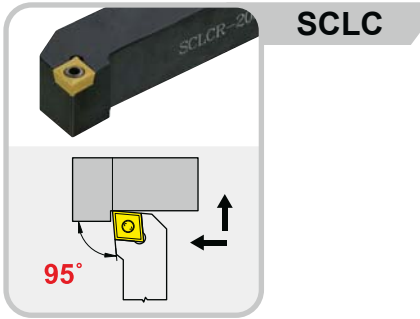

Right-hand shown

Order No. 訂購編碼	Dimensions, mm					Insert	Clamp 	Wrench 
	H	B	L	H1	f			
ISCLC <sup>R</sup> / <sub>L</sub> -1010H-06	10	10	100	10	12	CC..0602..	IMS2506A	ITK09
ISCLC <sup>R</sup> / <sub>L</sub> -1010K-06	10	10	125	10	12			
ISCLC <sup>R</sup> / <sub>L</sub> -1212H-09	12	12	100	12	16	CC..09T3..	IMS4011A	ITK15
ISCLC <sup>R</sup> / <sub>L</sub> -1212K-09	12	12	125	12	16			
ISCLC <sup>R</sup> / <sub>L</sub> -1616K-09	16	16	125	16	20			
ISCLC <sup>R</sup> / <sub>L</sub> -2020K-09	20	20	125	20	25			
ISCLC <sup>R</sup> / <sub>L</sub> -2525M-09	25	25	150	25	32			
ISCLC <sup>R</sup> / <sub>L</sub> -2020K-12	20	20	125	20	25	CC..1204..	IMS5011A	ITK20
ISCLC <sup>R</sup> / <sub>L</sub> -2525K-12	25	25	150	25	32			

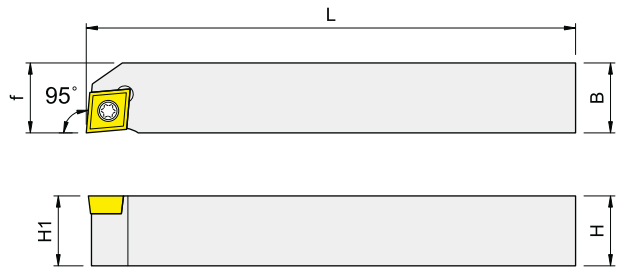
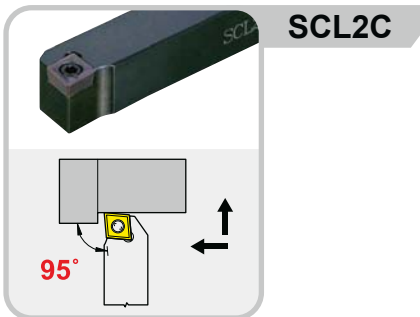

Right-hand shown

Order No. 訂購編碼	Dimensions, mm					Insert	Clamp 	Wrench 
	H	B	L	H1	f			
ISCL2C <sup>R</sup> / <sub>L</sub> -1010H-06	10	10	100	10	10	CC..0602..	IMS2506A	ITK09
ISCL2C <sup>R</sup> / <sub>L</sub> -1212H-09	12	12	100	12	12	CC..09T3..	IMS4011A	ITK15
ISCL2C <sup>R</sup> / <sub>L</sub> -1616K-09	16	16	125	16	16			
ISCL2C <sup>R</sup> / <sub>L</sub> -2020K-09	20	20	125	20	25			

Turning Tools

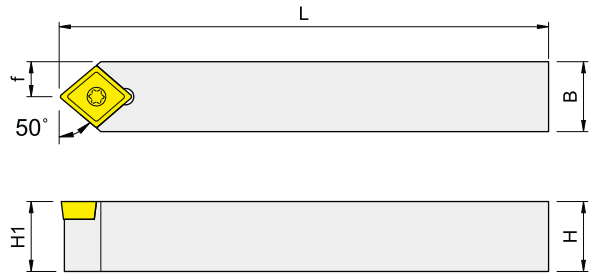
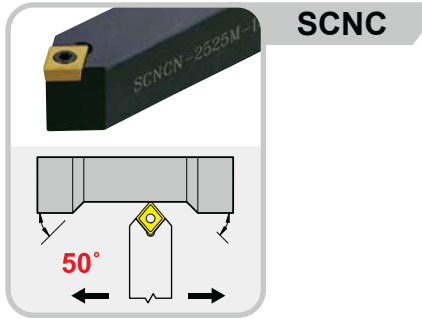

Order No. 訂購編碼	Dimensions, mm					Insert	Clamp 	Wrench 
	H	B	L	H1	f			
ISCNCN-1616K-06	16	16	125	16	8	CC..0602..	IMS2506A	ITK09
ISCNCN-1212K-09	12	12	125	12	6	CC..09T3..	IMS4011A	ITK15
ISCNCN-1616K-09	16	16	125	16	8			
ISCNCN-2020K-09	20	20	125	20	10			
ISCNCN-2525M-09	25	25	150	25	12.5	CC..1204..	IMS5011A	ITK20
ISCNCN-2020K-12	20	20	125	20	10			
ISCNCN-2525M-12	25	25	150	25	12.5			

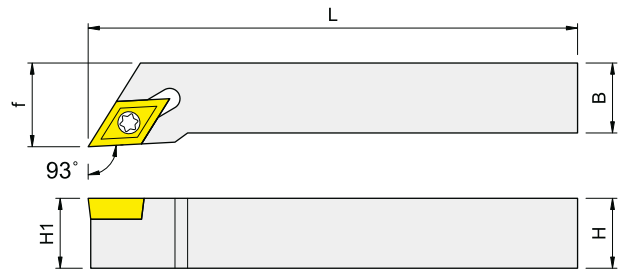
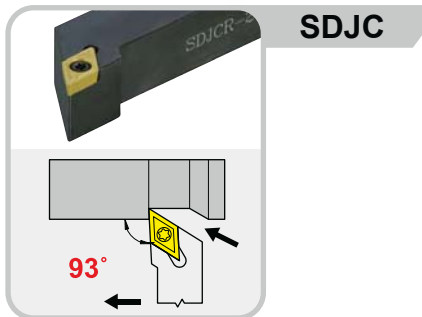

Right-hand shown

Order No. 訂購編碼	Dimensions, mm					Insert	Clamp 	Wrench 
	H	B	L	H1	f			
ISDJC <sup>R</sup> / <sub>L</sub> -1010H-07	10	10	100	10	12	DC..0702..	IMS2506B	ITK09
ISDJC <sup>R</sup> / <sub>L</sub> -1212H-07	12	12	100	12	16			
ISDJC <sup>R</sup> / <sub>L</sub> -1212K-07	12	12	125	12	16			
ISDJC <sup>R</sup> / <sub>L</sub> -1616K-07	16	16	125	16	20			
ISDJC <sup>R</sup> / <sub>L</sub> -2020K-07	20	20	125	20	25			
ISDJC <sup>R</sup> / <sub>L</sub> -1212H-11	12	12	100	12	16	DC..11T3..	IMS4009A	ITK15
ISDJC <sup>R</sup> / <sub>L</sub> -1212K-11	12	12	125	12	16			
ISDJC <sup>R</sup> / <sub>L</sub> -1616K-11	16	16	125	16	20			
ISDJC <sup>R</sup> / <sub>L</sub> -2020K-11	20	20	125	20	25			
ISDJC <sup>R</sup> / <sub>L</sub> -2525M-11	25	25	150	25	32			

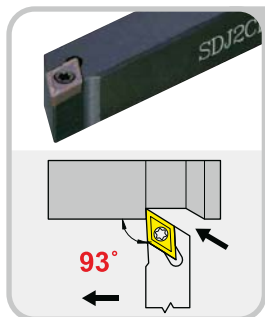

**SDJ2C**



**SDJ2CR-1010H/K-11**

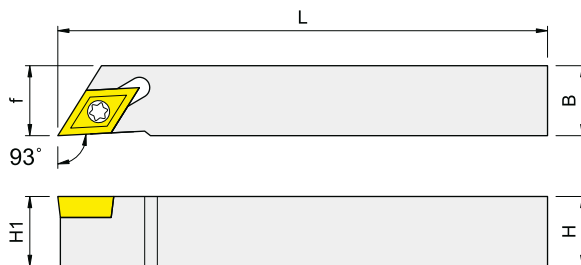

Right-hand shown

Order No. 訂購編碼	Dimensions, mm					Insert	Clamp 	Wrench 
	H	B	L	H1	f			
ISDJ2C <sup>R</sup> / <sub>L</sub> -1010H-07	10	10	100	10	10	DC..0702..	IMS2506B	ITK09
ISDJ2C <sup>R</sup> / <sub>L</sub> -1212H-07	12	12	100	12	12			
ISDJ2C <sup>R</sup> / <sub>L</sub> -1212K-07	12	12	125	12	12			
ISDJ2C <sup>R</sup> / <sub>L</sub> -1616K-07	16	16	125	16	16			
ISDJ2C <sup>R</sup> / <sub>L</sub> -2020K-07	20	20	125	20	20			
ISDJ2C <sup>R</sup> / <sub>L</sub> -2525M-07	25	25	150	25	25			
ISDJ2C <sup>R</sup> / <sub>L</sub> -1010H-11	10	10	100	10	10	DC..11T3..	IMS4009A	ITK15
ISDJ2C <sup>R</sup> / <sub>L</sub> -1010K-11	10	10	125	10	10		IMS4011A	
ISDJ2C <sup>R</sup> / <sub>L</sub> -1212H-11	12	12	100	12	12			
ISDJ2C <sup>R</sup> / <sub>L</sub> -1616K-11	16	16	125	16	16			
ISDJ2C <sup>R</sup> / <sub>L</sub> -2020K-11	20	20	125	20	20			
ISDJ2C <sup>R</sup> / <sub>L</sub> -2525M-11	25	25	150	25	25			
ISDJ2C <sup>R</sup> / <sub>L</sub> -3232P-11	32	32	170	32	32			

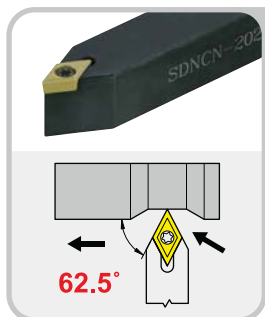

**SDNC**

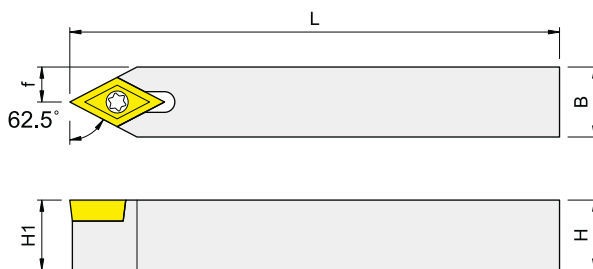

Order No. 訂購編碼	Dimensions, mm					Insert	Clamp 	Wrench 
	H	B	L	H1	f			
ISDNCN-1010H-07	10	10	100	10	5	DC..0702..	IMS2506B	ITK09
ISDNCN-1212H-07	12	12	100	12	6			
ISDNCN-1616K-07	16	16	125	16	8			
ISDNCN-1212H-11	12	12	100	12	6	DC..11T3..	IMS4011A	ITK15
ISDNCN-1212K-11	12	12	125	12	6			
ISDNCN-1616K-11	16	16	125	16	8			
ISDNCN-2020K-11	20	20	125	20	10			
ISDNCN-2525M-11	25	25	150	25	12.5			

Turning Tools

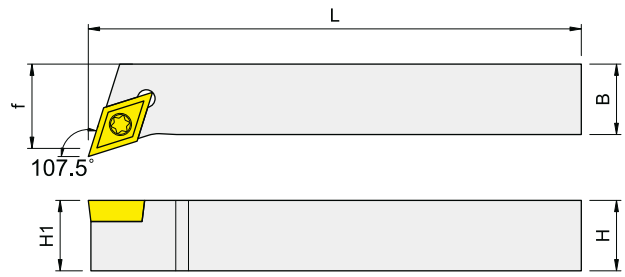
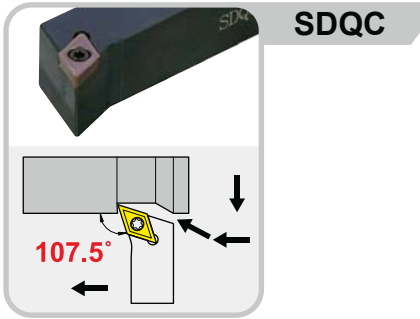

Right-hand shown

Order No. 訂購編碼	Dimensions, mm					Insert	Clamp 	Wrench 
	H	B	L	H1	f			
ISDQC <sup>R</sup> <sub>L</sub> -1212H-11	12	12	100	12	16	DC..11T3..	IMS4011A	ITK15
ISDQC <sup>R</sup> <sub>L</sub> -1616K-11	16	16	125	16	20			
ISDQC <sup>R</sup> <sub>L</sub> -2020K-11	20	20	125	20	25			
ISDQC <sup>R</sup> <sub>L</sub> -2525M-11	25	25	150	25	32			

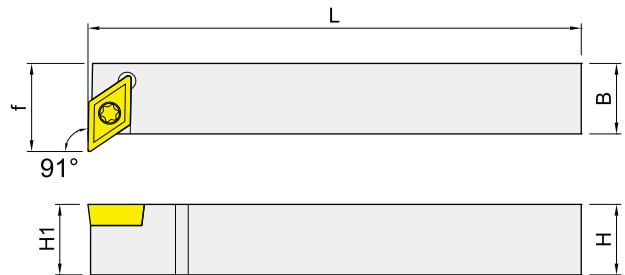
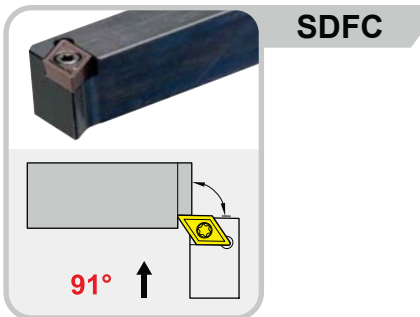

Right-hand shown

Order No. 訂購編碼	Dimensions, mm					Insert	Clamp 	Wrench 
	H	B	L	H1	f			
ISDFC <sup>R</sup> <sub>L</sub> -1212K-07	12	12	125	12	16	DC..0702..	IMS2506B	ITK09
ISDFC <sup>R</sup> <sub>L</sub> -1212K-11	12	12	125	12	19	DC..11T3..	IMS4011A	ITK15
ISDFC <sup>R</sup> <sub>L</sub> -1616K-11	16	16	125	16	20			

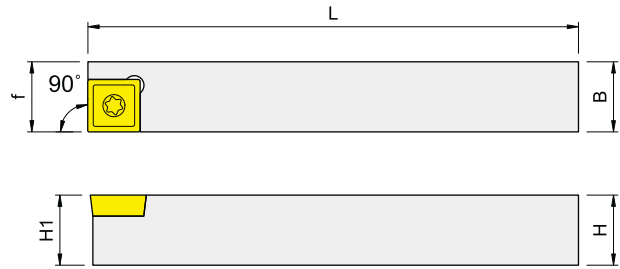
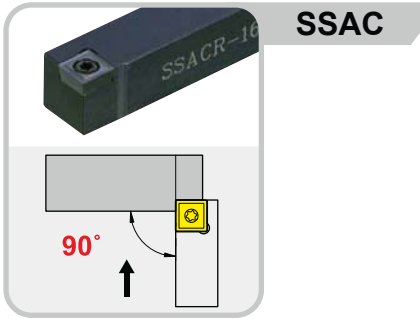

Right-hand shown

Order No. 訂購編碼	Dimensions, mm					Insert	Clamp 	Wrench 
	H	B	L	H1	f			
ISSAC <sup>R</sup> / <sub>L</sub> -3.4H-09	9.5	12.7	100	9.5	12.7	SC..09T3..	IMS4009A	ITK15
ISSAC <sup>R</sup> / <sub>L</sub> -4.4H-09	12.7	12.7	100	12.7	12.7		IMS4011A	ITK15
ISSACR-1212H-09	12	12	100	12	12			
ISSAC <sup>R</sup> / <sub>L</sub> -1616K-09	16	16	125	16	16			

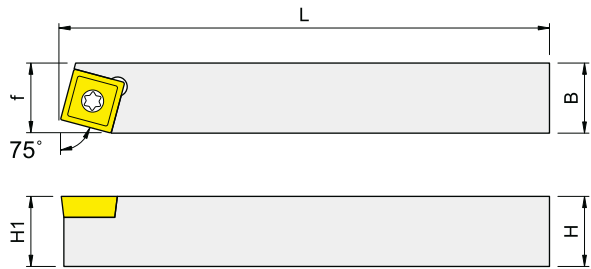
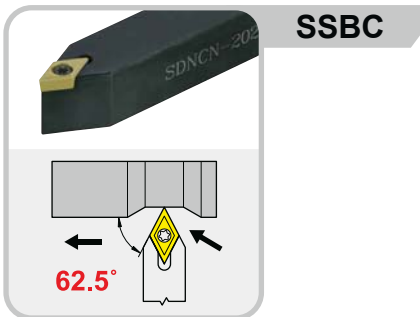

Right-hand shown

Order No. 訂購編碼	Dimensions, mm					Insert	Clamp 	Wrench 
	H	B	L	H1	f			
ISSBC <sup>R</sup> / <sub>L</sub> -3.4H-09	9.5	12.7	100	9.5	12.7	SC..09T3..	IMS4009A	ITK15
ISSBC <sup>R</sup> / <sub>L</sub> -4.4H-09	12.7	12.7	100	12.7	12.7		IMS4011A	ITK15
ISSBC <sup>R</sup> / <sub>L</sub> -1212H-09	12	12	100	12	12			

Turning Tools



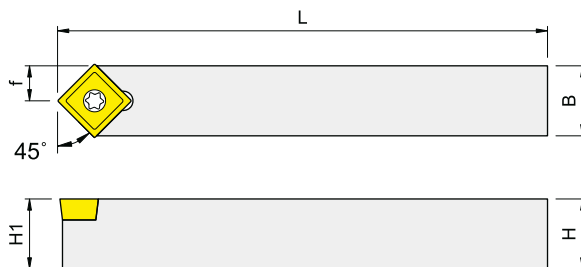
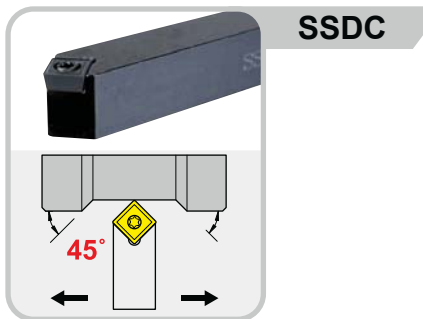

Order No. 訂購編碼	Dimensions, mm					Insert	Clamp 	Wrench 
	H	B	L	H1	f			
ISSDCN-3.4H-09	9.5	12.7	100	9.5	6.35	SC..09T3..	IMS4009A	ITK15
ISSDCN-4.4H-09	12.7	12.7	100	12.7	6.35	SC..09T3..	IMS4011A	ITK15
ISSDCN-1212H-09	12	12	100	12	6			
ISSDCN-1616K-09	16	16	125	16	8			
ISSDCN-2020K-09	20	20	125	20	10			
ISSDCN-2525M-09	25	25	150	25	12.5			

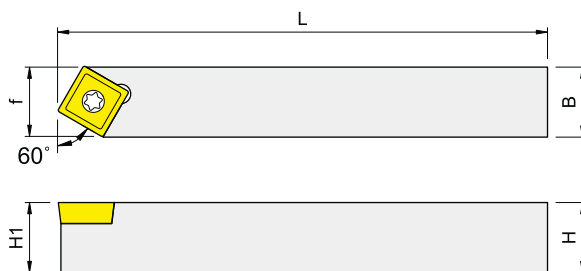
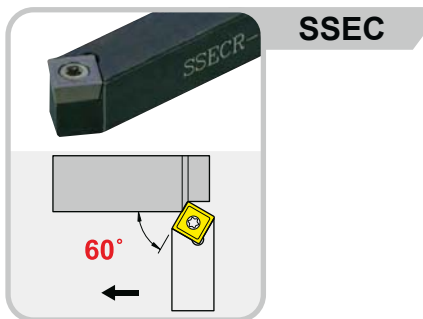

Right-hand shown

Order No. 訂購編碼	Dimensions, mm					Insert	Clamp 	Wrench 
	H	B	L	H1	f			
ISSEC <sup>R</sup> / <sub>L</sub> -3.4H-09	9.5	12.7	100	9.5	12.7	SC..09T3..	IMS4009A	ITK15
ISSEC <sup>R</sup> / <sub>L</sub> -4.4H-09	12.7	12.7	100	12.7	12.7	SC..09T3..	IMS4011A	ITK15
ISSEC <sup>R</sup> / <sub>L</sub> -1212H-09	12	12	100	12	12			

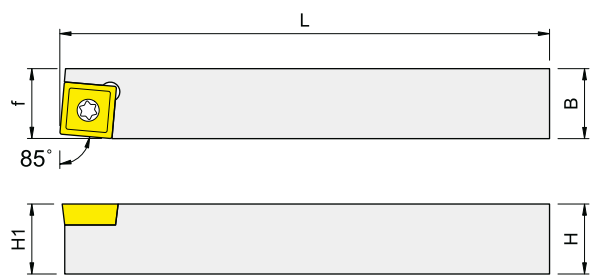
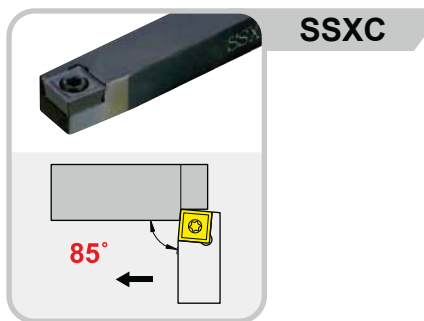

Right-hand shown

Order No. 訂購編碼	Dimensions, mm					Insert	Clamp 	Wrench 
	H	B	L	H1	f			
ISSXCR-3.4H-09	9.5	12.7	100	9.5	12.7	SC..09T3..	IMS4009A	ITK15

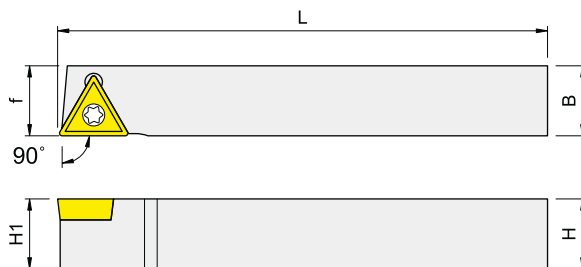
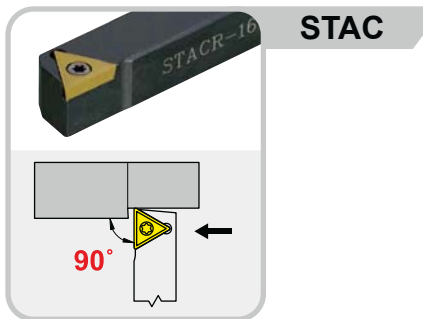

Right-hand shown

Order No. 訂購編碼	Dimensions, mm					Insert	Clamp 	Wrench 
	H	B	L	H1	f			
ISTACR-1010H-11	10	10	100	10	10	TC..1102..	IMS2506A	ITK09
ISTACR-1212H-11	12	12	100	12	12			
ISTACR-1616K-11	16	16	125	16	16			
ISTACR-3.4H-11	9.5	12.7	100	9.5	12.7			
ISTACR-4.4H-11	12.7	12.7	100	12.7	12.7			
ISTACR-1616K-16	16	16	125	16	16	TC..16T3..	IMS4011A	ITK15

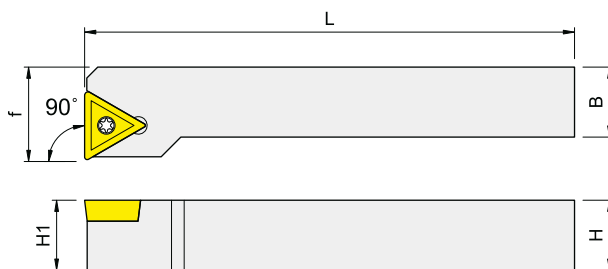
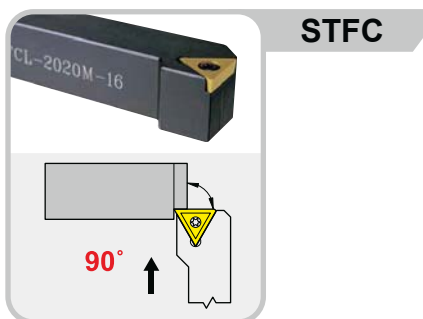

Right-hand shown

Order No. 訂購編碼	Dimensions, mm					Insert	Clamp 	Wrench 
	H	B	L	H1	f			
ISTFC <sup>R</sup> <sub>L</sub> -2020K-16	20	20	125	20	25	TC..16T3..	IMS4011A	ITK15
ISTFC <sup>R</sup> <sub>L</sub> -2525M-16	25	25	150	25	32			

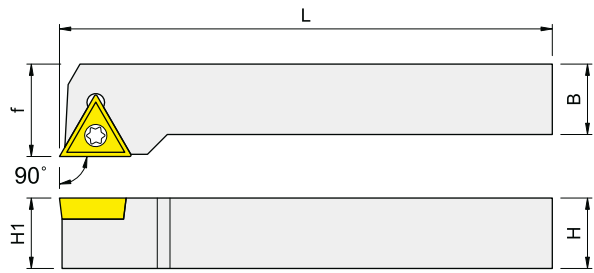
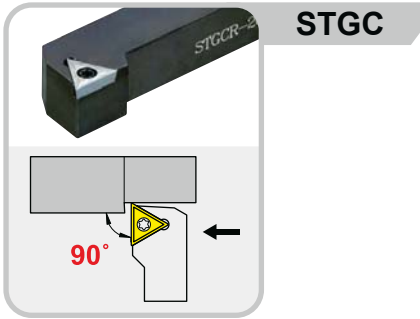

Right-hand shown

Order No. 訂購編碼	Dimensions, mm					Insert	Clamp	Wrench
	H	B	L	H1	f			
ISTGC <sup>R</sup> <sub>L</sub> -1212K-16	12	12	100	12	16	TC..16T3..	IMS4011A	ITK15
ISTGC <sup>R</sup> <sub>L</sub> -1616K-16	16	16	125	16	20			
ISTGC <sup>R</sup> <sub>L</sub> -2020K-16	20	20	125	20	25			
ISTGC <sup>R</sup> <sub>L</sub> -2525M-16	25	25	150	25	32			

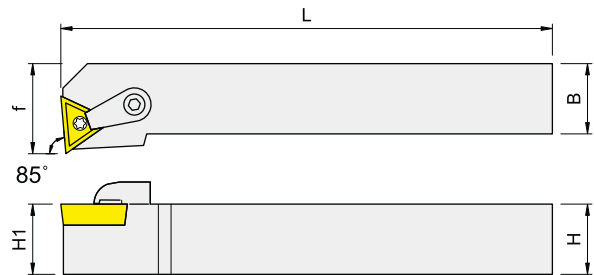
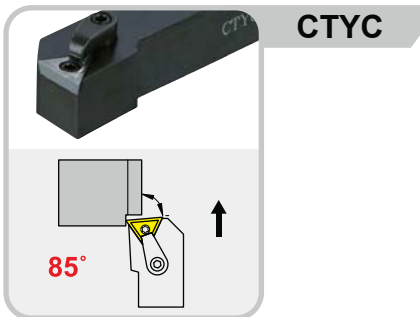

Right-hand shown

Order No. 訂購編碼	Dimensions, mm					Insert	Screw	Wrench	Screw	Clamp	Wrench
	H	B	L	H1	f						
ICTYC <sup>R</sup> <sub>L</sub> -2020K-16	20	20	125	20	25	TC..16T3..	IMS4011A	ITK15	IMS625TX	IMC620	IETL15

Turning Tools

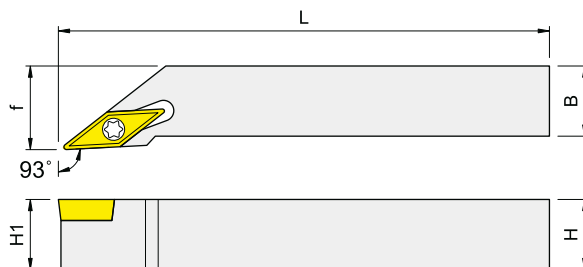
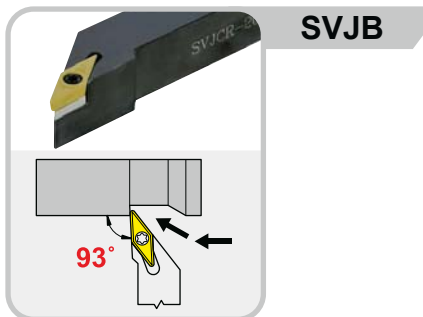

Right-hand shown

Order No. 訂購編碼	Dimensions, mm					Insert	Shim	Screw	Wrench	Screw	Wrench
	H	B	L	H1	f						
ISVJB <sup>R/L</sup> -1616K-16	16	16	125	16	20	VB..1604..	IVSS322	IMDS5035S	IPL35	IMS3512B	ITK15
ISVJB <sup>R/L</sup> -2020K-16	20	20	125	20	25						
ISVJB <sup>R/L</sup> -2525M-16	25	25	150	25	32						
ISVJC <sup>R/L</sup> -1010H-11	10	10	100	10	12	VC..1103..	--	--	--	IMS2506A	ITK09
ISVJC <sup>R/L</sup> -1212K-11	12	12	125	12	16						
ISVJC <sup>R/L</sup> -1616K-11	16	16	125	16	20						
ISVJC <sup>R/L</sup> -2020K-11	20	20	125	20	25						
ISVJC <sup>R/L</sup> -2525M-11	25	25	150	25	32						

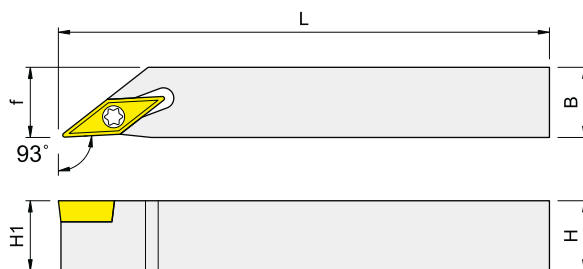
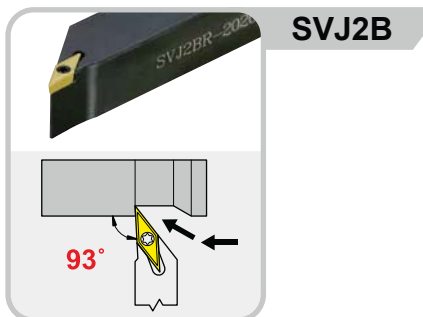

Right-hand shown

Order No. 訂購編碼	Dimensions, mm					Insert	Screw	Wrench	Screw	Clamp	Wrench
	H	B	L	H1	f						
ISVJ2C <sup>R/L</sup> -1010H-11	10	10	100	10	10	VC..1103..	--	--	--	IMS2506A	ITK09
ISVJ2C <sup>R/L</sup> -1212H-11	12	12	100	12	12						
ISVJ2C <sup>R/L</sup> -1616K-11	16	16	125	16	16						
ISVJ2C <sup>R/L</sup> -2020K-11	20	20	125	20	20						

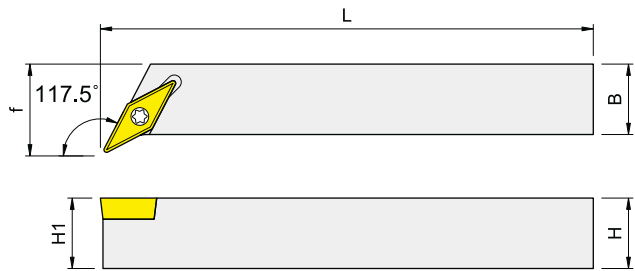
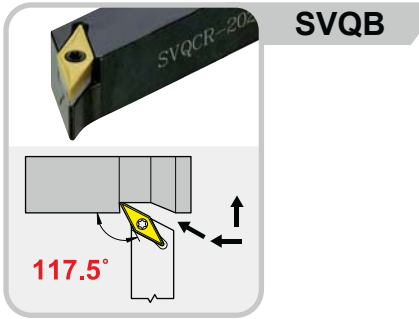

Right-hand shown

Order No. 訂購編碼	Dimensions, mm					Insert	Shim	Screw	Wrench	Screw	Wrench
	H	B	L	H1	f						
ISVQB <sup>R</sup> <sub>L</sub> -2020K-16	20	20	125	20	25	VB..1604..	IVSS322	IMDS5035S	IPL35	IMS3512B	ITK15
ISVQB <sup>R</sup> <sub>L</sub> -2525M-16	25	25	150	25	32						
ISVQC <sup>R</sup> <sub>L</sub> -1212H-11	12	12	100	12	16	VC..1103..	--	--	--	IMS2506A	ITK09
ISVQC <sup>R</sup> <sub>L</sub> -1616K-11	16	16	125	16	20						
ISVQC <sup>R</sup> <sub>L</sub> -2020K-11	20	20	125	20	25						

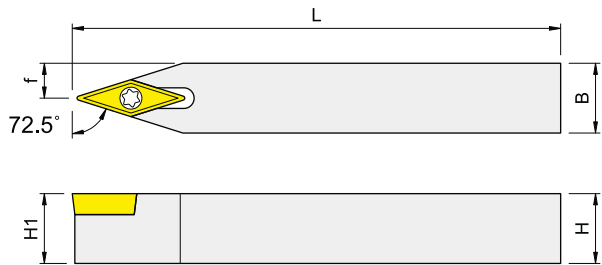
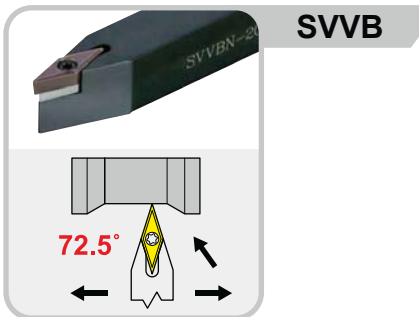

Order No. 訂購編碼	Dimensions, mm					Insert	Screw	Wrench	Screw	Clamp	Wrench
	H	B	L	H1	f						
ISVVBN-1616K-16	16	16	125	16	8	VB..1604..	IVSS322	IMDS5035S	IPL35	IMS3512B	ITK15
ISVVBN-2020K-16	20	20	125	20	10						
ISVVBN-2525M-16	25	25	150	25	12.5						
ISVVCN-1010H-11	10	10	100	10	5	VC..1103..	--	--	--	IMS2506A	ITK09
ISVVCN-1212K-11	12	12	125	12	6						
ISVVCN-1616K-11	16	16	125	16	8						
ISVVCN-2020K-11	20	20	125	20	10						
ISVVCN-2525M-11	25	25	150	25	12.5						

Turning Tools